

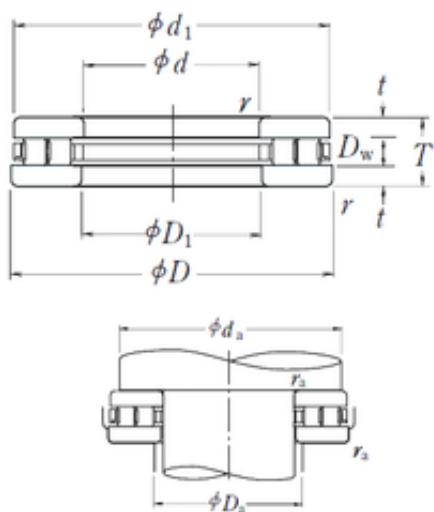

# GGB BEARING CO., LTD.



## NSK 300TMP11 CYLINDRICAL ROLLER THRUST BEARINGS

Bearing No. 300TMP11

Size	300x380x62 mm
Bore Diameter	300 mm
Outer Diameter	380 mm
Width	62 mm
d	300 mm
D	380 mm
hidYobi	300TMP11
LangID	1
D_	380
C	795
B_	62
hidTable	ecat_NSCRT
Oil rpm	900
mass	16.7
d1	376
GRS rpm	300
ra	2
D_a	315
C0	4000
D_1	304
Prod_Type3	TB_TCRB_A
da	365
DA_	25
Z_	33
Dw	25

300TMP11 Bearing 2D drawings and 3D CAD models



## GGB BEARING CO., LTD.

yobi	300TMP11
RAC	150
t	18.5
r	2
T_	62
KBRG	4614